



PICKLEBALL LIGHTING

Official Lighting Partner of USA Pickleball



Sun City Festival
Buckeye, AZ



LSI is the *official lighting partner*
of USA Pickleball





EXPERIENCE MAKES THE DIFFERENCE

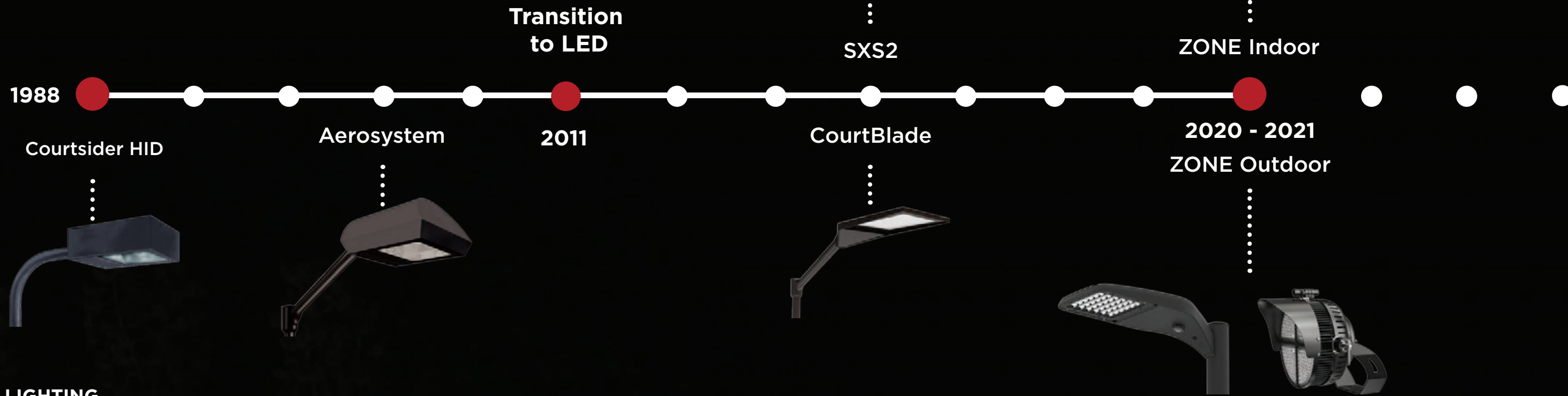

HID LIGHTING

INDUSTRY STANDARD

**ZONE™ IS THE
NEW
INDUSTRY STANDARD**

Headquartered in Cincinnati, Ohio, LSI is a leading producer of high-performance, American-made lighting solutions. With a focus on outdoor courts, LSI fixtures became the standard with the introduction of the Courtsider. With the evolution of LED, the CourtBlade quickly became the optical leader with superior light control. ZONE is now the next generation in sport court lighting. By staying close to the sports markets, LSI is the clear choice for illuminating indoor and outdoor courts.



OUTDOOR COURT LIGHTING



ZONE

ZONE OUTDOOR AREA LIGHTS

Our sleek, low profile ZONE™ fixtures are game changers for pickleball court lighting applications. High-performance LEDs and precise optics produce superior levels of court illumination and uniformity.

Key Features

- ZONE is specifically designed for sports court illumination with LSI's exclusive molded silicone optical system
- Court optics maximize player visibility with no uplight to meet USA Pickleball requirements for horizontal and vertical court illumination
- Exceptional backlight control reduces spill light
- Optional integral louvers and house side shields further limit light trespass
- LEDs available in 4000K or 5000K color temperatures with a rated life in excess of 100,000 hours
- Die-cast aluminum housing available in two sizes (ZNM & ZNL) depending on light level requirements for Category I, II or III courts
- LSI's DuraGrip® protects the luminaire in extreme weather without cracking or peeling
- Suitable for wet locations and Ingress Protection Rated (IP66) against dirt and moisture
- Designed and manufactured in Cincinnati, OH for quick delivery
- 5-year limited warranty



ZONE Large (ZNL)
Up to 78,000 Lumens

ZONE Medium (ZNM)
Up to 48,000 Lumens

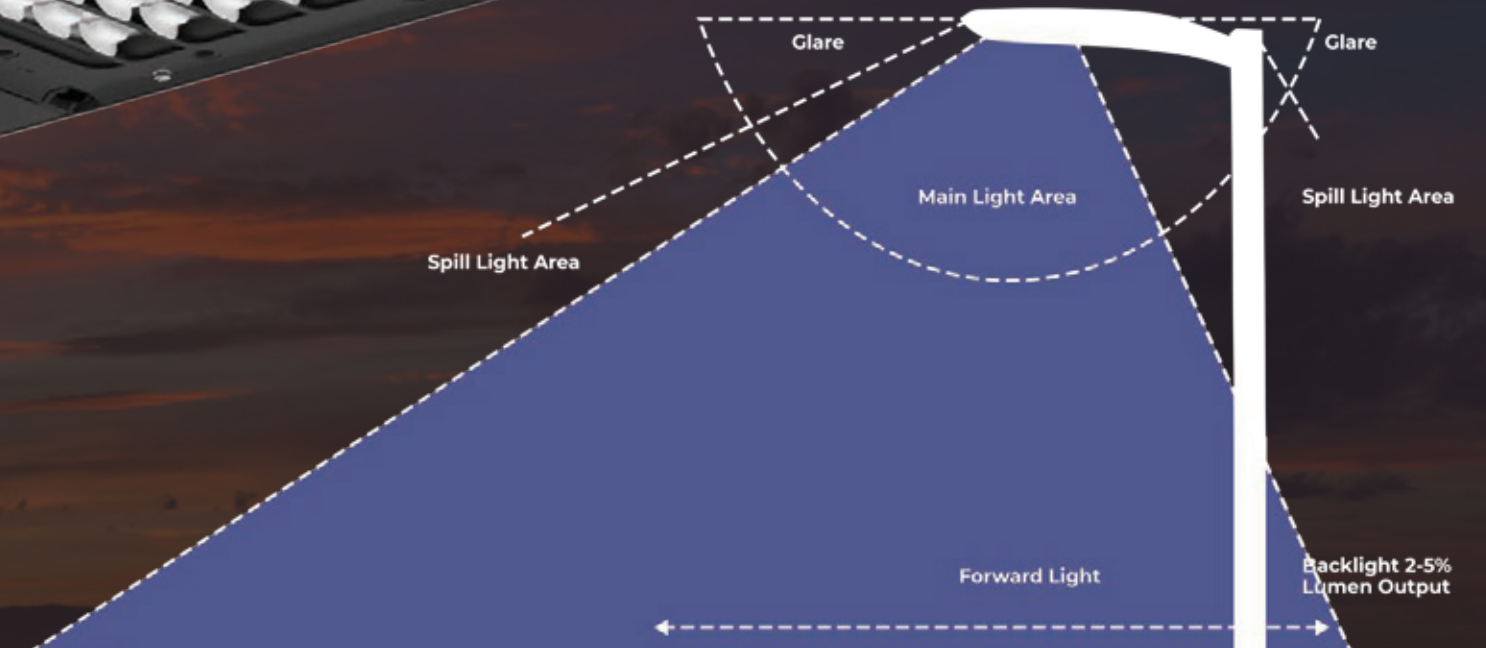

Performance shown is with integral louver shield.



WE PLACE LIGHT WHERE YOU NEED IT

WHY SILICONE OPTICS?

- Proprietary silicone refractor optics designed specifically for court applications, provide superior light coverage and uniformity.
- State-of-the-Art one-piece silicone optic sheet delivers industry leading optical control with an integrated gasket to provide IP66 rating.
- Shatterproof lens
- Outperforms acrylic and polycarbonate lenses in the toughest conditions



Performance Court Optic
Excellent Backlight Control

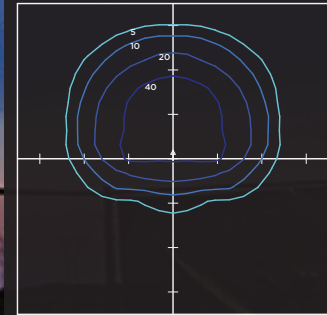

Performance Court Optic
with Houseside Shield

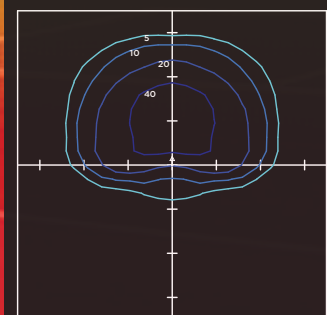

Performance Court Optic
with Louver - Best Backlight Control

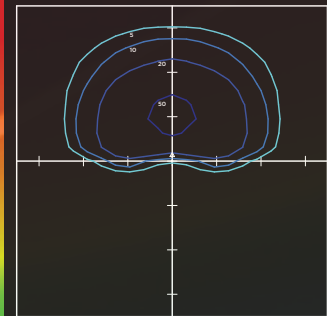

CONTROL YOUR LIGHTING

We offer two wireless outdoor lighting control systems that are ideal for pickleball courts.

AIRLINK BLUE

- Simple, highly configurable wireless control system
- Bluetooth Mesh technology
- Fixture integrated motion sensors
- System settings are easily changed with iOS smartphone app
- User friendly interface
- Setup multiple zones, each with their own configuration
- Add a Time Keeper and configure based on the time of day

[AIRLINK BLUE >](#)

AIRLINK OUTDOOR

- Highly configurable wireless control system
- Utilizes a 2.4 GHz self-healing mesh network
- Web interface for remote and local access
- Menu allows quick view and edit of fixtures, zones, scenes & schedules
- Fixture integrated motion sensors
- Group fixtures into zones to manage daily functions
- Scheduling and timed event capabilities
- Satellite map view displays energy usage information

[AIRLINK OUTDOOR >](#)



*Wireless configuration illustration







POLES & ACCESSORIES FOR ANY COURT LAYOUT

- Durable, long-lasting performance
- Poles are sized to fit any court, with heights ranging from 10' to 99'.
- Color options to match your court design
- Multiple fixture bracket options to support your court configuration

ZONE AREA LIGHTING

- Most common is from 18' to 24'
- Available in:
 - Square, round or tapered versions
 - Steel, aluminum or fiberglass
- Easy to customize with additional power outlets and mounting brackets for other options to enhance the player experience
- Designed and manufactured in Cincinnati, Ohio for quick delivery
- Every pole is provided with the DuraGrip® Protection System and a 5-year limited warranty
- Available with the DuraGrip® Plus Protection System - including a non-porous, automotive grade corrosion coating applied to the lower portion of the pole interior, sealing and further protecting it from corrosion. This option extends the limited warranty to 7 years.

Tenon Mount Bracket	Round Straight Pole w/ Tenon Top	Power Outlet Options
 <p>Allows for mounting multiple fixtures to a pole tenon top and provides rotatability to insure the fixture heads are properly oriented.</p>		

ZONE FLOOD LIGHTING

- Most common in 40' to 99' height
- Available in:
 - Round tapered
 - Steel, Galvanized Steel
- Cages and crossarms available
- Manufactured in America
- 1 year warranty

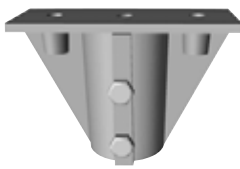
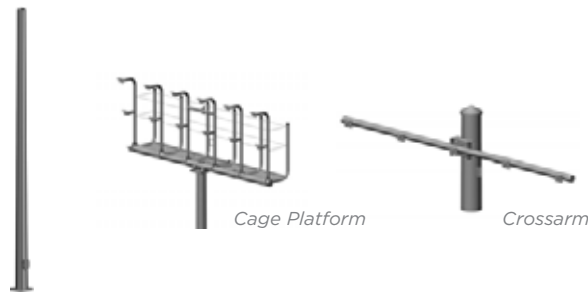
Tenon Top Bracket	Yoke Mount	Flood Light Pole, Cage Platform and Crossarm
		 <p>Cage Platform Crossarm</p>

LIGHTING SOLUTIONS AT ALL LEVELS

Our powerful online tools help users design custom court lighting for single or multi-court projects (including resorts and sport complexes). All courts are designed to USA Pickleball recommended levels based on the category of play from recreational to professional.

Below is a representation of typical outdoor pickleball court lighting to compare the three categories of play. Contact the LSI Technical Design Team for support reviewing designs created with our online Create-A-Court Design Selector.

Recommended Horizontal Illumination				Recommended Vertical Illumination			
Performance Criteria	Category I	Category II	Category III	Performance Criteria	Category I	Category II	Category III
Average Maintained Horizontal Foot-candles within PPA	75 (750 lux)	50 (500 lux)	30 (300 lux)	Average Maintained Vertical Foot-candles within PPA	50 (500 lux)	30 (300 lux)	20 (200 lux)
Minimum Maintained Horizontal Foot-candles within PPA	60 (600 lux)	40 (400 lux)	20 (200 lux)	Maximum Uniformity Ratio	1.7	2.0	2.0
Maximum Uniformity Ratio	1.7	2.0	2.0				

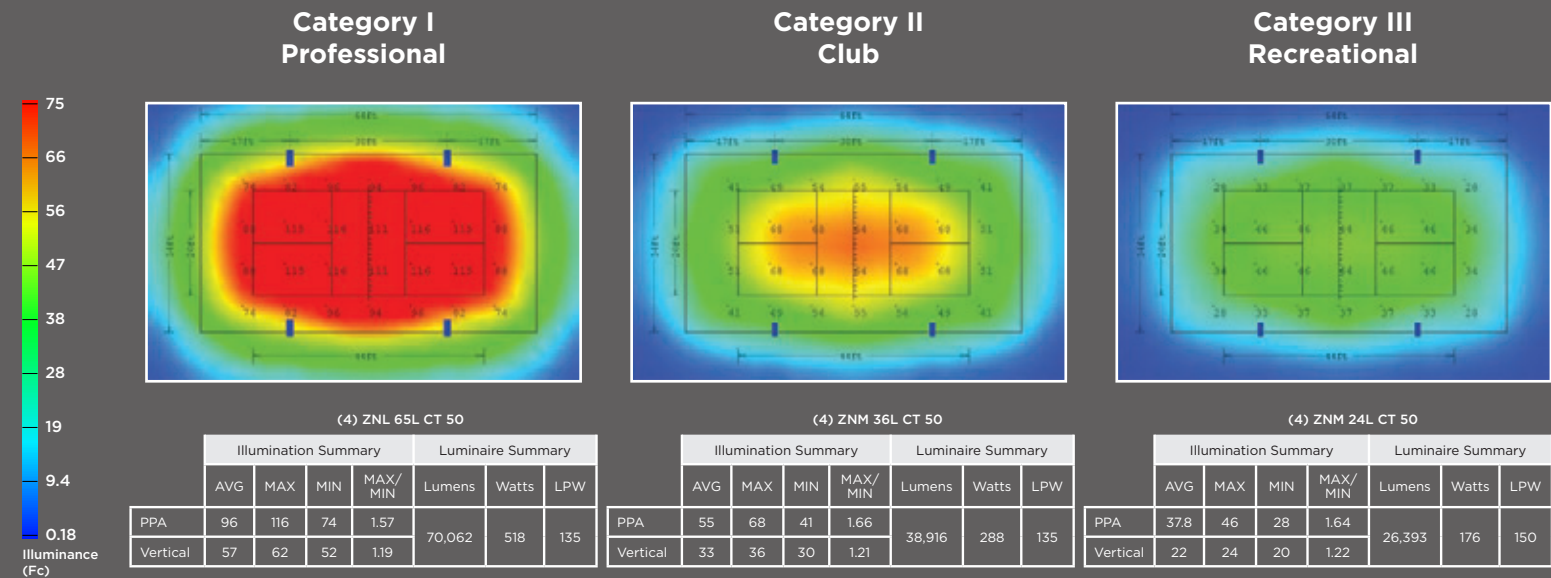

Primary Playing Area (PPA) includes 6' beyond sidelines and 10' beyond baselines. Vertical illuminance calculated at 3' above net. Luminaires mounted on 20' poles.

HOW TO CREATE YOUR COURT

Use the Create-A-Court Design Selector to find the appropriate LED lighting design for your specific pickleball lighting needs.

[VISIT US ONLINE TO GET STARTED >](#)

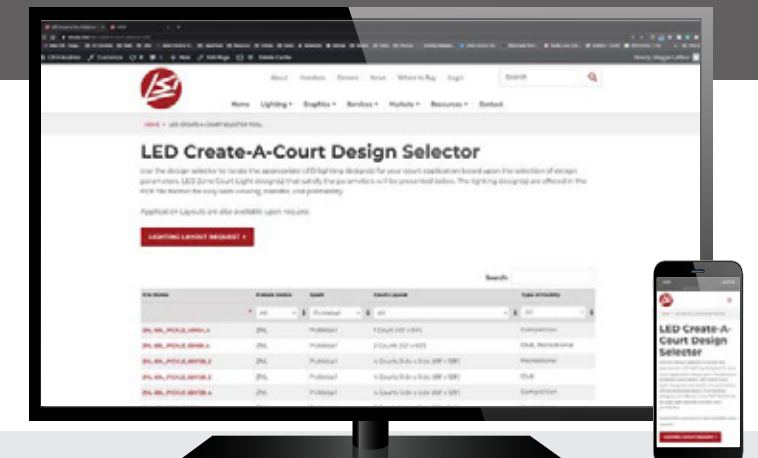

ZONE FLOOD LIGHT

The ZONE Sports Flood is designed for large facilities that require tall poles made to hold multiple fixtures illuminating courts on both sides of the pole. Among the most affordable products in its class, the ZONE Sports Flood is energy-efficient, extremely durable, lightweight, and perfect for new construction and retrofit projects. Its modern design features yoke and tenon mounting options with horizontal and vertical aiming guides. There's also an optional laser sight for pinpoint accuracy across four NEMA flood distributions. The ZONE Sports Flood's housing is highly effective at dispersing heat - protecting the driver and LEDs to ensure a long service life of up to 70,000 hours. Whether you're building a new outdoor athletic facility or simply replacing outdated HID lighting technology, our ZONE Sports Flood is the right solution to satisfy the players, spectators, and overall community.

SPECIFICATIONS			
LUMENS	70,000	85,000	100,000
WATTAGE	450	550	740
CCT	4000L, 5000K		
CRI	70		
VOLTAGE	120-277, 347-480		
LPW	up to 157		
TEMP RANGE	-40° F to 122° F		
EPA	2.5		
WEIGHT	38lbs	40lbs	42lbs
LIFE	Up to 70,000 hours		
WARRANTY	5 Years		

NEMA DISTRIBUTIONS

The ZONE Sports Flood is available with four NEMA flood distributions which enable precise lighting for a variety of sports applications, levels of play and court sizes.

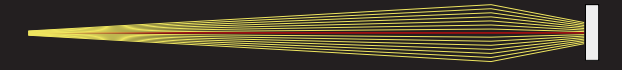

2x2

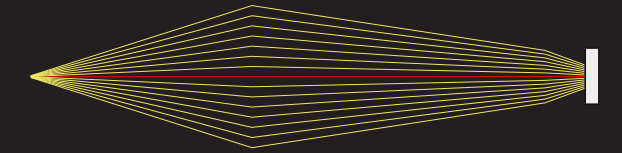

3x3

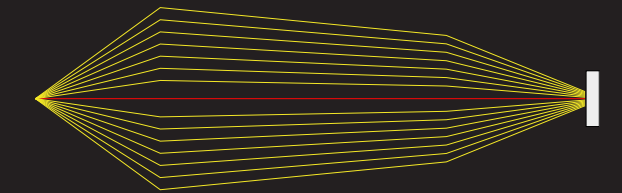

4x4

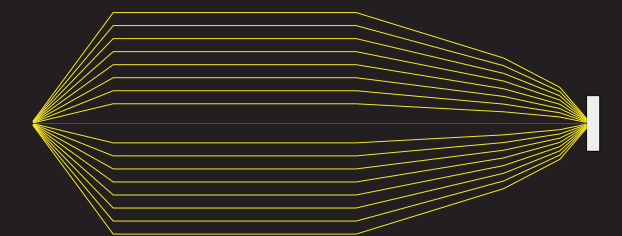

5x5

THERMAL MANAGEMENT

Heatsinks designed with a broad heat radiation surface area to effectively cool LEDs for a life of up to 70,000 hours.

OPTICS

4 unique NEMA flood distributions.

LIGHT ENGINE VENTS

Allow convection cooling of LEDs for superior performance and long life.

INSTALLATION

Heavy duty yoke mounting

CONSTRUCTION

Rugged aluminum IP66 housing with a separate electrical driver compartment and light engine enclosure.

AIMING

Horizontal and vertical aiming guides and ergonomic tool-less locking handle. Optional laser sight for precise aiming accuracy.

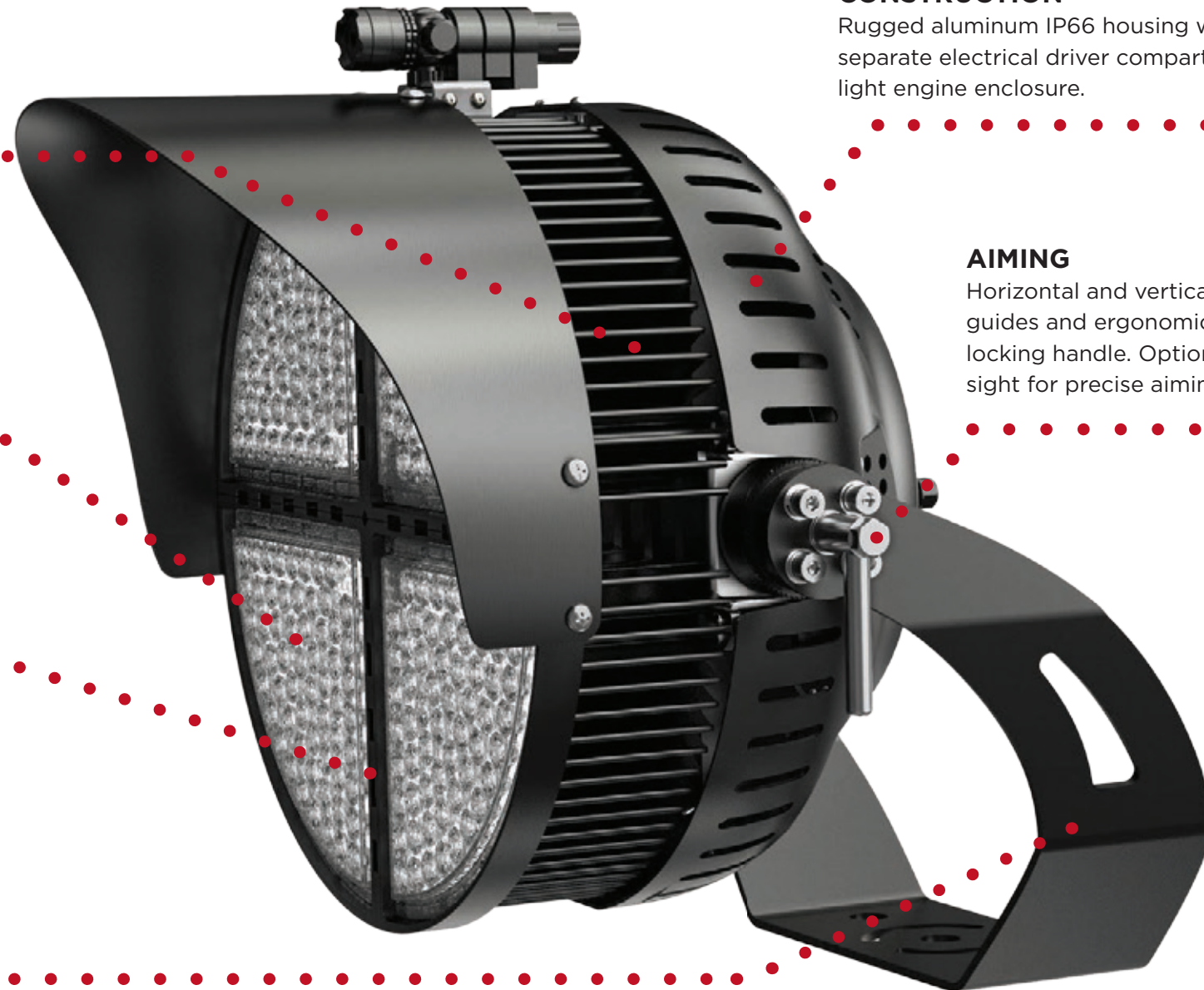



INDOOR COURT LIGHTING



ZONE



ZONE Indirect (ZNIA)
Up to 75,000 Lumens

ZONE INDIRECT SPORTS LIGHT

- Designed specifically for indoor sport courts
- High-performance and glare-free indirect light
- Industry-leading light output - up to 75,000 lumens
- High-quality polyester coated sheet metal construction and lens geometry are designed to withstand impact
- 5-year limited warranty
- Controls options include LSI's AirLink wireless control systems and sensors for energy savings and code compliance
- UL 1598 and UL 8750 listed, State of California Title 24 compliant with appropriate controls, meets Buy American Act (BAA) requirements
- Designed and manufactured in the USA with quick delivery

CHOOSE YOUR BRIGHTNESS

USA Pickleball and the American Sports Builders Association recommend specific illumination levels for the three categories of play and a fourth higher level for Tournament venues requiring broadcast quality television lighting. Below is a representation of typical indoor pickleball court lighting to compare the three categories of play.

Recommended Horizontal Illumination			
Performance Criteria	Category I	Category II	Category III
Average Maintained Horizontal Foot-candles within PPA	75 (750 lux)	50 (500 lux)	30 (300 lux)
Minimum Maintained Horizontal Foot-candles within PPA	60 (600 lux)	40 (400 lux)	20 (200 lux)
Maximum Uniformity Ratio	1.7	2.0	2.0

Recommended Vertical Illumination			
Performance Criteria	Category I	Category II	Category III
Average Maintained Vertical Foot-candles within PPA	50 (500 lux)	30 (300 lux)	20 (200 lux)
Maximum Uniformity Ratio	1.7	2.0	2.0

Category II – Club

Primary Playing Area (PPA) includes 6' beyond sidelines and 10' behind baselines. Vertical illuminance calculated at 3' above net. Luminaires mounted 16' above playing surface. 4 courts covering about 10,000 square feet.

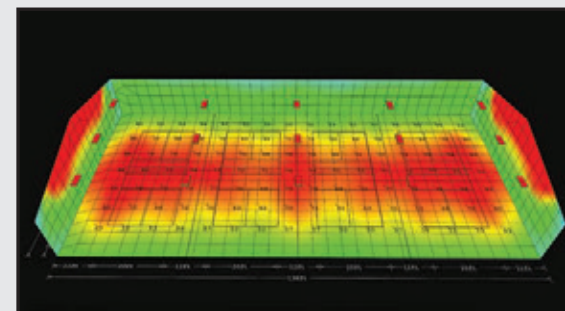
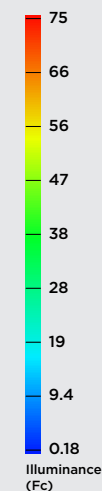

	(15) ZNIA-2LEDSE-55L-CA-W-40						
	Illumination Summary				Luminaire Summary		
	AVG	MAX	MIN	MAX/MIN	Lumens	Watts	LPW
PPA	65	77	50	1.54	57,551	428	134
Vertical	42	46	38	1.22			



PICKLEBALL INSTALLATIONS





PGA Village Verano Pickleball Center
Port St. Lucie, FL



LSI is the *official lighting partner* of USA Pickleball



Official pickleball court lighting provider for the IFP



Exclusive lighting partner of APP

ZONE™ in on high-performance, game changing illumination!

FOR MORE INFORMATION

Visit us online: www.lsicorp.com

Email us: pickleball@lsicorp.com

or

Call us: (800) 436-7800

Application photography provided by Frasure Reps, LLC, Cincinnati OH, 45208. A strategic LSI partner for court lighting.

Visit us online at www.lsicorp.com



Anthem Community Center
Anthem, AZ



LSI Industries Inc. 10000 Alliance Rd. Cincinnati, OH 45242 • www.lsicorp.com
(800) 436-7800 • ©2021 LSI Industries Inc. All Rights Reserved.

08/17/2021
PRBR.0529.B.0821