



Catalog #: _____ Project: _____

Prepared By: _____ Date: _____ Type: _____

Mirada Medium Wall Sconce (XWM)

Outdoor Wall Sconce



IK08



OVERVIEW	
Lumen Range	3,000 - 21,000
Wattage Range	23 - 175
Efficacy Range (LPW)	125 - 158
Weight lbs(kg)	30 (13.6)

QUICK LINKS

[Ordering Guide](#)[Performance](#)[Photometrics](#)[Dimensions](#)

FEATURES & SPECIFICATIONS

Construction

- Rugged die-cast aluminum housing contains factory prewired driver and optical unit. Hinged die-cast aluminum wiring access door located underneath.
- Galvanized-steel universal wall mount bracket comes standard with hinging mechanism to easily access the junction box wire connections without removing the luminaire.
- Optional pole-mounting bracket (XPMa) permits mounting to standard poles.
- Fixtures are finished with LSI's DuraGrip® polyester powder coat finishing process. The DuraGrip finish withstands extreme weather changes without cracking or peeling. Other standard LSI finishes available. Consult factory.
- Shipping weight: 30 lbs in carton.

Optical System

- State-of-the-Art one piece silicone optic sheet delivers industry leading optical control with an integrated gasket to provide IP65 rated sealed optical chamber in 1 component.
- Proprietary silicone refractor optics provide exceptional coverage and uniformity in Types 2, 3, and Forward Throw (FT) distributions.
- Silicone optical material does not yellow or crack with age and provides a typical light transmittance of 93%.
- Zero uplight.
- Available in 5000K, 4000K and 3000K color temperatures per ANSI C78.377. Also Available in Phosphor Converted Amber with Peak intensity at 610nm.
- Minimum CRI of 70.

Electrical

- High-performance programmable driver features over-voltage, under-voltage, short-

circuit and over temperature protection. Custom lumen and wattage packages available.

- 0-10V dimming (10% - 100%) standard.
- Standard Universal Voltage (120-277 Vac) Input 50/60 Hz or optional High Voltage (347-480 Vac).
- L80 Calculated Life: >100k Hours
- Total harmonic distortion: <20%
- 3L to 12L operating temperature: -40°C to +50°C (-40°F to +122°F)
- 15L operating temperature: -40°C to +45°C (-40°F to +113°F).
- 18L operating temperature: -40°C to +40°C (-40°F to +104°F).
- 21L operating temperature: -40°C to +35°C (-40°F to +95°F).
- Power factor: >.90
- Input power stays constant over life.
- Optional 10kV surge protection device meets a minimum Category C Low operation (per ANSI/IEEE C62.41.2).
- High-efficacy LEDs mounted to metal-core circuit board to maximize heat dissipation
- Components are fully encased in potting material for moisture resistance. Driver complies with FCC standards. Driver and key electronic components can easily be accessed via hinged door.
- Optional integral emergency battery pack provides 90-minutes of constant power to the LED system, ensuring code compliance. A test switch/indicator button is installed on the housing for ease of maintenance. The fixture delivers 1500 lumens during emergency mode.

Controls

- Integral passive infrared Bluetooth™ motion and photocell sensor options. Fixtures operate independently and can be commissioned via an iOS or Android configuration app. Updates and modifications to the control strategy are

easily implemented via an intuitive app.

- LSI's AirLink™ Blue lighting control system is a simple feature rich wireless Bluetooth mesh network. The integrated fixture sensor module provides wireless control of grouped fixtures based on motion sensors, daylight or a fully customizable schedule.

Installation

- Universal wall mounting plate easily mounts directly to 4" octagonal or square junction box.
- 2 fasteners secure the hinged door underneath the housing and provide quick & easy access to the electrical compartment for installing/servicing.
- Optional terminal block accepts up to 12 ga wire.

Warranty

- LSI LED Fixtures carry a 5-year warranty.
- 1 Year warranty on Battery Back-up option.

Listings

- Listed to UL 1598 and UL 8750.
- Meets Buy American Act requirements.
- IDA compliant; with 3000K or lower color temperature selection.
- Title 24 Compliant; see local ordinance for qualification information.
- Suitable for wet Locations.
- IP65 rated luminaire per IEC 60598.
- 3G rated for ANSI C136.31 high vibration applications when pole mounted (using optional XPMa bracket) or wall mounted.
- IK08 rated luminaire per IEC 66262 mechanical impact code
- DesignLights Consortium® (DLC) qualified product. Not all versions of this product may be DLC qualified. Please check the DLC Qualified Products List at www.designlights.org/QPL to confirm which versions are qualified.



Mirada Wall Sconce (XWM)

ORDERING GUIDE

[Back to Quick Links](#)TYPICAL ORDER EXAMPLE: **XWM 2 LED 03L 30 UE BRZ ALSC**

Family	Distribution	LED Technology	Lumen Package	Color Temperature	Voltage
XWM - Mirada Medium Wall Sconce	2 - Type 2 3 - Type 3 FT - Type 4 Forward Throw	LED	3L - 3,000 lms 4L - 4,000 lms 6L - 6,000 lms 8L - 8,000 lms 12L - 12,000 lms 15L - 15,000 lms 18L - 18,000 lms 21L - 21,000 lms Custom Lumen Packages ⁶	30 - 3000K 40 - 4000K 50 - 5000K AMB - Phosphor Converted Amber ¹	UE - Universal Voltage (120-277V) HV - High Voltage (347-480V)

Finish	Controls (Choose One)	Options
BLK - Black BRZ - Dark Bronze GMG - Gun Metal Gray GPT - Graphite MSV - Metallic Silver PLP - Platinum Plus SVG - Satin Verde Green WHT - White	Wireless Controls ALSC - AirLink Synapse Control System ALSCS01 - AirLink Synapse Control System with 8-12' Motion Sensor ALSCS02 - AirLink Synapse Control System with 12-20' Motion Sensor ALBSC1 - AirLink Blue Wireless Motion & Photo Sensor Controller (8-24' mounting height) ALBSC2 - AirLink Blue Wireless Motion & Photo Sensor Controller (25-40' mounting height) Standalone Controls DIM - 0-10v Dimming Leads extended to housing exterior IMSBT1 - Integral Bluetooth™ Motion and Photocell Sensor max 8-24' mounting height ⁴ IMSBT2 - Integral Bluetooth Motion and Photocell Sensor max 25-40' mounting height ⁴ Button Type Photocells PC120 - 120V PC1208-277 - 208 -277V PC347 - 347V	BB - Battery Back-up (0°C) ² CWBB - Cold Weather Battery Backup (-20°C) ² XPMA - Pole Mounting Bracket SPI - 10kV Surge Protection TB - Terminal Block

ACCESSORY ORDERING INFORMATION⁷

Description	Order Number	Description	Order Number
XWM Surface Wiring Box	356915CLR	FK347 - Single Fusing	FK347 ⁵
10' Linear Bird Spike Kit (2' Recommended per Luminaire)	751632	DFK - Double Fusing	DFK208 ⁵
FK120 - Single Fusing	FK120 ⁵	DFK - Double Fusing (240V)	DFK240 ⁵
FK277 - Single Fusing	FK277 ⁵	DFK - Double Fusing (480V)	DFK480 ⁵

- Only available in 6L Lumen Package. Consult factory for lead time and availability.
- Not available in HV.
- Consult Factory for Site Layout.
- IMSBT is field configurable via the LSI app that can be downloaded from your smartphone's native app store.
- Fusing must be located in a hand hole for pole or in the junction box.
- Custom lumen and wattage packages available consult factory. Values are within industry standard tolerances but not DLC listed.
- Accessories are shipped separately and field installed.



Mirada Wall Sconce (XWM)

PERFORMANCE

[Back to Quick Links](#)

DELIVERED LUMENS*												
Lumen Package	Distribution	CRI	3000K			4000K			5000K			Wattage
			Delivered Lumens	Efficacy	BUG Rating	Delivered Lumens	Efficacy	BUG Rating	Delivered Lumens	Efficacy	BUG Rating	
03L	2	70	3178	138	B1-U0-G1	3368	146	B1-U0-G1	3313	143	B1-U0-G1	23
	3	70	3224	140	B1-U0-G1	3416	148	B1-U0-G1	3361	145	B1-U0-G1	
	FT	70	3160	137	B1-U0-G1	3349	145	B1-U0-G1	3294	143	B1-U0-G1	
04L	2	70	4230	139	B1-U0-G1	4483	147	B1-U0-G1	4410	145	B1-U0-G1	30
	3	70	4291	141	B1-U0-G1	4547	150	B1-U0-G1	4473	147	B1-U0-G1	
	FT	70	4206	138	B1-U0-G1	4458	147	B1-U0-G1	4385	144	B1-U0-G1	
06L	2	70	6326	134	B2-U0-G1	6704	142	B2-U0-G2	6595	140	B2-U0-G2	47
	3	70	6417	136	B1-U0-G2	6800	144	B1-U0-G2	6689	142	B1-U0-G2	
	FT	70	6290	134	B2-U0-G2	6666	142	B2-U0-G2	6557	139	B2-U0-G2	
08L	2	70	8166	128	B2-U0-G2	8654	135	B2-U0-G2	8513	133	B2-U0-G2	64
	3	70	8283	129	B2-U0-G2	8778	137	B2-U0-G2	8635	134	B2-U0-G2	
	FT	70	8120	126	B2-U0-G2	8605	134	B2-U0-G2	8465	132	B2-U0-G2	
12L	2	70	11902	146	B3-U0-G2	12358	151	B3-U0-G2	12927	158	B3-U0-G2	82
	3	70	11834	145	B2-U0-G2	12287	150	B2-U0-G2	12853	157	B2-U0-G2	
	FT	70	11737	143	B2-U0-G2	12186	149	B2-U0-G2	12747	156	B2-U0-G2	
15L	2	70	14662	140	B3-U0-G3	15223	145	B3-U0-G3	15924	152	B3-U0-G3	105
	3	70	14603	139	B2-U0-G2	15162	145	B2-U0-G3	15860	151	B2-U0-G3	
	FT	70	14502	139	B2-U0-G3	15057	144	B2-U0-G3	15750	150	B2-U0-G3	
18L	2	70	17403	134	B3-U0-G3	18069	139	B3-U0-G3	18901	145	B3-U0-G3	130
	3	70	17438	134	B3-U0-G3	18106	139	B3-U0-G3	18940	146	B3-U0-G3	
	FT	70	17259	133	B3-U0-G3	17920	138	B3-U0-G3	18745	144	B3-U0-G3	
21L	2	70	20380	127	B3-U0-G3	21160	132	B3-U0-G3	22134	138	B4-U0-G3	161
	3	70	20375	125	B3-U0-G3	21155	131	B3-U0-G3	22129	131	B3-U0-G3	
	FT	70	20215	126	B3-U0-G3	20989	130	B3-U0-G3	21955	136	B3-U0-G3	

*LEDs are frequently updated therefore values are nominal.

ELECTRICAL DATA*							
Lumen Package	120V	208V	240V	277V	347V	480V	
03L	0.19	0.11	0.10	0.08	0.07	0.05	
04L	0.25	0.15	0.13	0.11	0.09	0.06	
06L	0.39	0.23	0.20	0.17	0.14	0.10	
08L	0.54	0.31	0.27	0.23	0.19	0.13	
12L	0.68	0.39	0.34	0.30	0.24	0.17	
15L	0.87	0.50	0.44	0.38	0.30	0.22	
18L	1.08	0.63	0.54	0.47	0.37	0.27	
21L	1.34	0.77	0.67	0.58	0.46	0.34	

*Electrical data at 25C (77F). Actual wattage may differ by +/-10%.

DELIVERED LUMENS*					
Lumen Package	Distribution	Amber			Wattage
		Delivered Lumens	Efficacy	BUG Rating	
6L	2	3325	76	B1-U0-G1	43.5
	3	3385	78	B1-U0-G1	
	FT	3343	77	B1-U0-G1	

RECOMMENDED LUMEN MAINTENANCE (3L-8L) ¹					
Ambient Temperature C	Initial ²	25K hrs. ²	50K hrs. ³	75K hrs. ³	100K hrs. ³
0 C - 50 C	100%	98%	95%	93%	90%

RECOMMENDED LUMEN MAINTENANCE (12L-21L) ¹					
Ambient Temperature C	Initial ²	25K hrs. ²	50K hrs. ³	75K hrs. ³	100K hrs. ³
0 - 35 C	99%	97%	95%	93%	91%

- 1 - Lumen maintenance values at 25C are calculated per TM-21 based on LM-80 data and in-situ testing.
- 2 - In accordance with IESNA TM-21-11, Projected Values represent interpolated value based on time durations that are within six times the IESNA LM-80-08 total test duration for the device under testing.
- 3 - Lumen maintenance values at 25C are calculated per TM-21 based on LM-80 data and in-situ testing times the IESNA LM-80-08 total test duration for the device under testing



Mirada Wall Sconce (XWM)

[Back to Quick Links](#)

PHOTOMETRICS

All published luminaire photometric testing performed to IESNA LM-79 standards. ISO footcandle plots below demonstrate the Mirada Wall Sconce (XWM) light patterns only. Not for total fixture output. For complete specifications and IES files, see website.

XWM-2-LED-6L-40

LUMINAIRE DATA

Type 2 Distribution	
Description	4000 Kelvin, 70 CRI
Delivered Lumens	6,025
Watts	44.7
Efficacy	135
IES Type	Type III - Medium
BUG Rating	B2-U0-G2

Zonal Lumen Summary

Zone	Lumens	%Luminaire
Low (0-30)°	807.1	13.4%
Medium (30-60)°	3301.0	54.8%
High (60-80)°	1847.4	30.7%
Very High (80-90)°	69.2	1.1%
Uplight (90-180)°	0.0	0.0%
Total Flux	6024.7	100%

ISO FOOTCANDLE PLOT

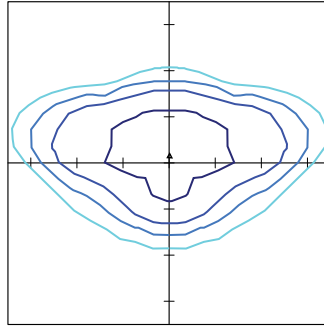

15' Mounting Height / 10' Grid Spacing



POLAR CURVE

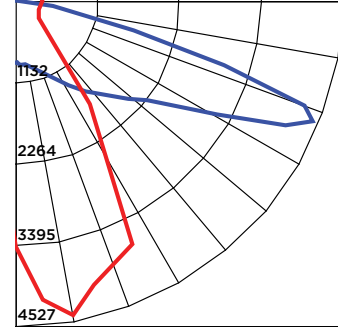

XWM-3-LED-6L-40

LUMINAIRE DATA

Type 3 Distribution	
Description	4000 Kelvin, 70 CRI
Delivered Lumens	6,133
Watts	44.7
Efficacy	137
IES Type	Type III - Medium
BUG Rating	B1-U0-G2

Zonal Lumen Summary

Zone	Lumens	%Luminaire
Low (0-30)°	567.4	9.3%
Medium (30-60)°	3106.3	50.6%
High (60-80)°	2368.8	38.6%
Very High (80-90)°	90.7	1.5%
Uplight (90-180)°	0.0	0.0%
Total Flux	6133.2	100%

ISO FOOTCANDLE PLOT

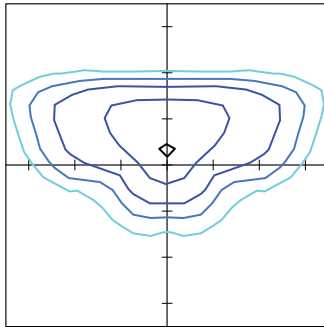

10' Mounting Height / 10' Grid Spacing



POLAR CURVE

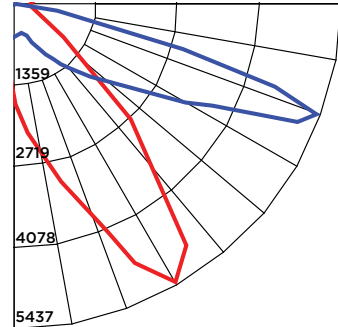

XWM-FT-LED-6L-40

LUMINAIRE DATA

Type FT Distribution	
Description	4000 Kelvin, 70 CRI
Delivered Lumens	6,058
Watts	44.7
Efficacy	136
IES Type	Type IV - Short
BUG Rating	B1-U0-G2

Zonal Lumen Summary

Zone	Lumens	%Luminaire
Low (0-30)°	779.0	12.9%
Medium (30-60)°	2584.4	42.7%
High (60-80)°	2523.2	41.7%
Very High (80-90)°	170.8	2.8%
Uplight (90-180)°	0.0	0.0%
Total Flux	6057.4	100.0%

ISO FOOTCANDLE PLOT

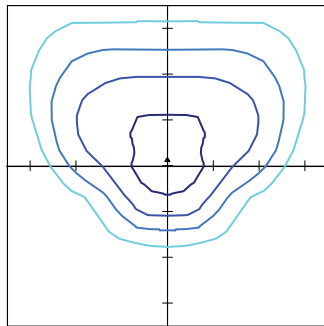

10' Mounting Height / 10' Grid Spacing



POLAR CURVE

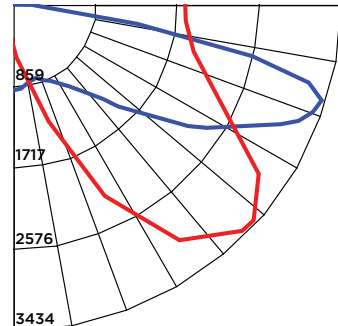



Mirada Wall Sconce (XWM)

PRODUCT DIMENSIONS

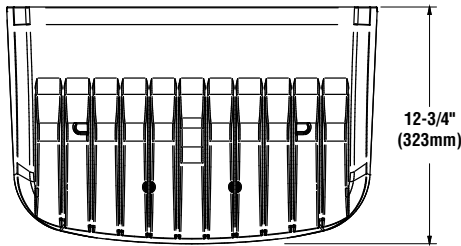
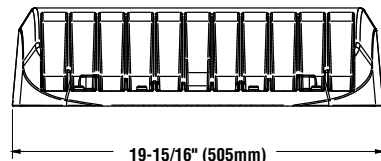
[Back to Quick Links](#)12-3/4"
(323mm)

19-15/16" (505mm)

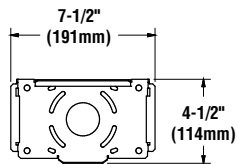
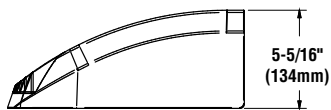
7-1/2"
(191mm)4-1/2"
(114mm)5-5/16"
(134mm)

Luminaire Shown with IMSBT

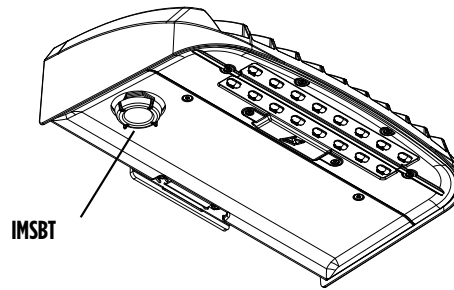

IMSBT

Surface Wiring Box

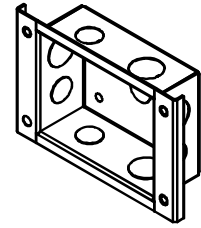

Wet location rated surface wiring box features 1/2" and 3/4" knockouts for surface conduit

Luminaire Shown with PCI

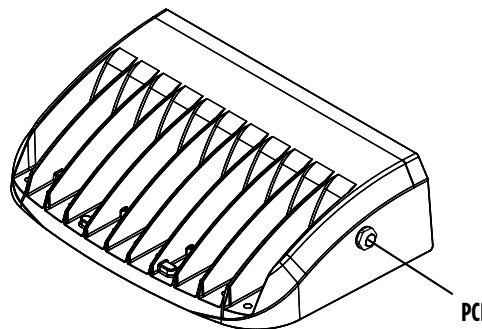

PCI

CONTROLS

AirLink Wireless Lighting Controller

The AirLink integrated controller is a California Title 24 compliant lighting controller that provides real-time light monitoring and control with utility-grade power monitoring. It includes a 24V sensor input and power supply to connect a sensor into the outdoor AirLink wireless lighting system. The wireless integrated controller is compatible with this fixture.

[Click here to learn more about AirLink.](#)

Integral Bluetooth™ Motion and Photocell Sensor (IMSBT)

Slim low profile sensor provides multi-level control based on motion and/or daylight. Sensor controls 0-10 VDC LED drivers and is rated for cold and wet locations (-30° C to 70° C). Two unique PIR lenses are available and used based on fixture mounting height. All control parameters are adjustable via an iOS or Android App capable of storing and transmitting sensor profiles.

[Click here to learn more about IMSBT.](#)

AirLink Blue

Wireless Bluetooth Mesh Outdoor Lighting Control System that provides energy savings, code compliance and enhanced safety/security for parking lots and parking garages. Three key components; Bluetooth wireless radio/sensor controller, Time Keeper and an iOS App. Capable of grouping multiple fixtures and sensors as well as scheduling time-based events by zone. Radio/Sensor Controller is factory integrated into Area/Site, Wall Mounted, Parking Garage and Canopy luminaires.

[Click here to learn more about AirLink Blue.](#)